



# HYDRO TRACKER

## User Manual

# HYDRO TRACKER

## User Manual





No part of this manual, including the products and software described in it, may be reproduced, transmitted, transcribed, stored in a retrieval system, or translated into any language in any form or by any means, except documentation kept by the purchaser for backup purposes, without the express written permission of AJAX DETECTION TECHNOLOGY LTD. («AJAX»).

Product warranty or service will not be extended if: (1) the product is repaired, modified or altered, unless such repair, modification or alteration is authorized in writing by AJAX: or (2) the serial number of the product is defaced or missing.

Ajax provides this manual «as is» without warranty of any kind, either Express or implied, including but not limited to the implied warranties for Conditions of merchantability or fitness for a particular purpose. In no Event shall ajax, its directors, officers, employees or agents be liable for any Indirect, special, incidental, or consequential damages (including damages For loss of profits, loss of business, loss of use or data, interruption of Business and the like), even if ajax has been advised of the possibility of such Damages arising from any defect or error in this manual or product.

Specifications and information contained in this manual are furnished For informational use only, and are subject to change at any time without Notice, and should not be construed as a commitment by ajax. Ajax assumes No responsibility or liability for any errors or inaccuracies that may appear In this manual, including the products and software described in it.

Products and corporate names appearing in this manual may or may not be registered trademarks or copyrights of their respective companies, and are used only for identification explanation and to the owners benefit, without intent to infringe.

<b>Content</b> .....	3	<b>Advanced Scan</b> .....	21
<b>Safety Instructions</b> .....	4	Ground Type .....	22
<b>Device Overview</b> .....	5	Target Depth .....	23
<b>Technical Specifications</b> .....	6	Distance Between Probes .....	23
<b>Package Components</b> .....	7	Scan Info .....	24
<b>Package Components</b> .....	8	<b>Ground Imaging Scan</b> .....	25
<b>Initial Setup</b> .....	9	2D Graph .....	26
<b>Main User Interface</b> .....	10	3D Graph .....	27
<b>Languages</b> .....	10	Rotate .....	27
<b>Time &amp; Date</b> .....	11	Zoom In .....	28
<b>Volume</b> .....	11	Upper View .....	28
<b>Display</b> .....	12	Side View .....	28
<b>Moisture</b> , Temperature Measurement & Signal filtering Unit .....	13	Depth Check .....	29
<b>How To Use</b> moisture & Temperature Measurement & Signal filtering Unit .....	14	Reset .....	29
<b>Factory Reset</b> .....	15	<b>How To Save Scans</b> .....	30
<b>About The Device</b> .....	16	<b>Files</b> .....	31
<b>General Instructions</b> .....	17	<b>Battery &amp; Charger</b> .....	32
<b>Manual Scan</b> .....	18	<b>Notes</b> .....	34
<b>Automatic Scan</b> .....	19	<b>Contact Info</b> .....	37

## Safety Instructions



Components used in this device are susceptible to damage from electrostatic discharges. Please comply with the following instructions to ensure successful assembly of the device.

Ensure that all components of the device are securely connected. Loose connection points may result in parts not being recognized or failure to operate.

It is recommended that you discharge yourself from static charges by touching a grounded metal surface before starting to work with the appliance

Keep the device in an environment free of negative charges when not using the device.



Do not assemble or operate the device before reading and understanding the user manual, as this may result in damage or injury to the device or the operator.



If assistance is required during the installation or tuning process, please contact technical support by phone or the Internet.



Always turn off the device completely before storing it.



Keep this user guide for future reference.



Keep the device away from humidity.

Ensure that the electrical socket provides the same voltage as indicated on the charger before plugging the charger into the socket. All cautions and warnings on the device and within the user manual must be noted and considered.

**If any of the following occur, have the device checked at a service center:**

- 1 A liquid substance has penetrated the device.
- 2 The device has been exposed to high humidity.
- 3 The device does not work well, or you cannot operate it according to the user manual.
- 4 The device has been dropped or damaged.
- 5 There is a clear sign of damage or harm on the device.

Do not leave the device in an environment with a temperature higher than 60°C (140°F). The device may be damaged.

For more information and to see the latest updates regarding products and systems from:

### 1. [AJAX website](#)

The Ajax website provides updated information regarding hardware, software, and equipment. Refer to the contact information page.

### 2. [Other documents.](#)

The product may include additional documents such as warranty papers or additional guarantees added by the distributor. These documents are not included in the default product package.

## Device Overview

The Hydro Tracker device is a new design with the utmost perfection and distinction, advanced systems and high levels of technology that have been approved by the experts and engineers of Ajax Company, and the latest findings of the company in the field of exploration and detection of groundwater, the device contains 4 different high-precision systems that give you accurate results and with complete details that gives you complete confidence to reach your target precisely, through a 7-inch color screen that is very accurate and clear in all circumstances. The device is also equipped with a measurement unit for soil temperature and moisture, which also works to purify the signal at a high rate, and this ensures the accuracy of processing the results and reaching them correctly and ideally.

## Technical Specifications

Operate Principal	Analyzing signals, processing data, and converting them into visual results.
Display Screen	TFT Color, 7 inch 480*800 WVGA, color depth 24 bit
Battery	Internal, Lithium Ion 7.4 V, 7000mAh (52 W)
Power consumption	Average consumption 400 mAh
Battery working hours	More than 12 hours continuous when the battery is fully charged (Working hours may differ according to screen brightness, volume level and scan operations)
Electrical Charger	Power input 100-240V AC, Output (PD 12V.1.5A)
Volume	High quality mono sound.
Languages	Provided in 8 languages
Time & Date	Yes
Device Weight	9.75 KG
Bag Dimensions	23*40*52 cm
Package Dimensions	23.5*42*54 cm
Operating Temperature	From (-10 C° to + 60 C°) – From ( 50 F° to 140 F°)
Provided in 8 languages	From (-10 C° to + 80 C°) – From ( 50F° to 176F°)

## Package Components

- 1 Device bag
- 2 Signal filtering unit and soil temperature and moisture measurement
- 3 Ground scan probe, 42 cm long / 4 pieces
- 4 24m wire roller / 4pcs
- 5 Connecting clip / 4pcs
- 6 Short connecting cable / 4pcs
- 7 Charger
- 8 Charger cable

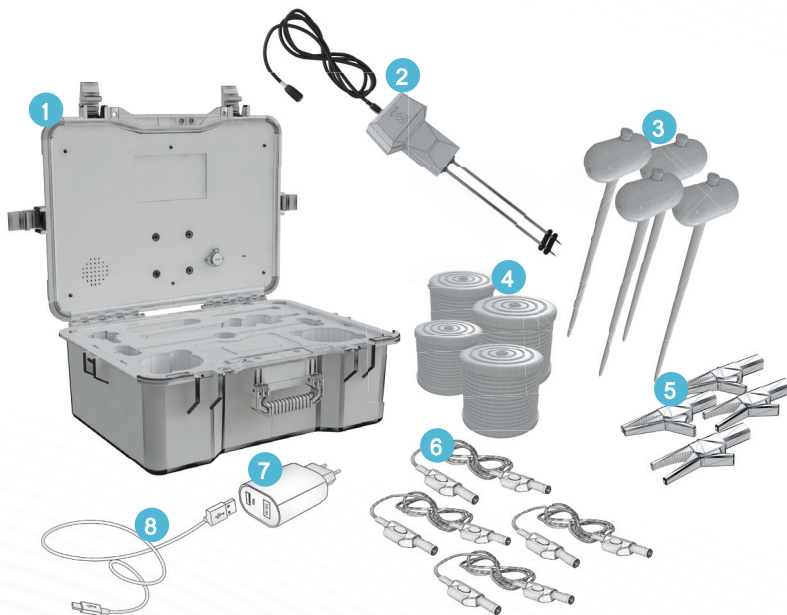







## Control Keys

Enter : Confirm and enter the chosen option

Back : To return to previous menu or cancel.

Navigation Arrows    : move within user interface and control systems' options

ON/OFF : Long press for seconds to switch ON and OFF .

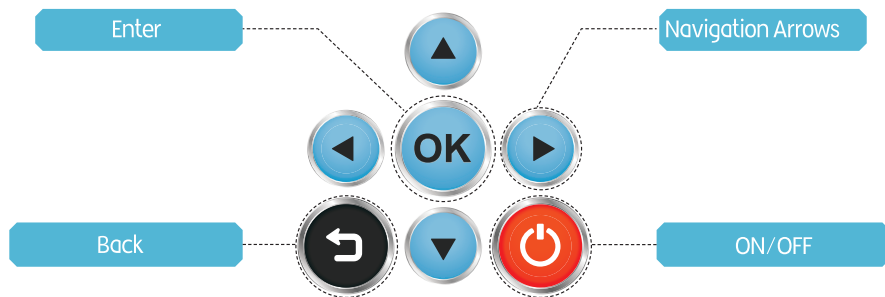

When booting the device for the first time or after factory reset, please follow the instructions shown on the screen for initial setup for time & date.

## Initial Setup

When starting the device for the first time or after factory reset you should set the time and date.

- 1 Start the device: long press the power key for seconds.
- 2 Choose the preferred language and press **OK**.
- 3 Set time & date.

### Time & Date format:

Time: Hour:Minute:Second

Date: Day/Month/Year

Then press **OK**

The main interface will show up after.

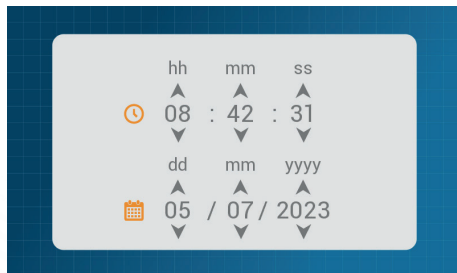

## Main User Interface

- 1 Manual Scan
- 2 Automatic Scan
- 3 Advanced Scan
- 4 Imaging Scan
- 5 Files
- 6 Settings

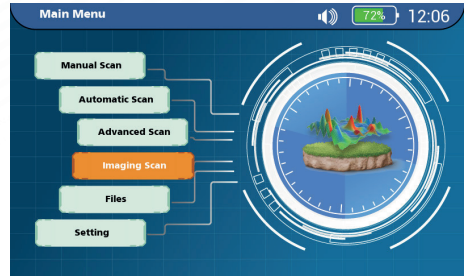

## Languages

The device supports eight languages for the user interface which are:

English, German, French, Arabic, Spanish, Turkish, Russian, Urdu)

Choose the preferred language and press  then press the Back key to save the chosen language within the new settings.

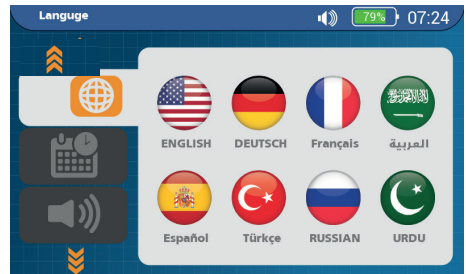

## Time & Date

Set the time and date through changing values using the navigation arrows up and down. ⏴ ⏵

Note: Time format is 24 hours.

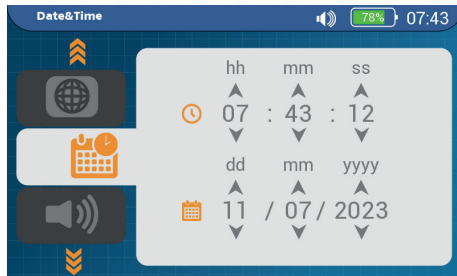

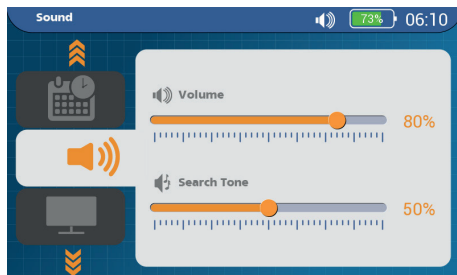

## Volume

Set the volume level for tones, alarms, scans and startup tone through changing the values using ⏴ ⏵ navigation arrows. Then press the ⏮ key to save changes.



## Display

### Brightness

Set the brightness level by changing values using the   arrows the press the back key  to save changes. Brightness level is changeable from 10% - 100%

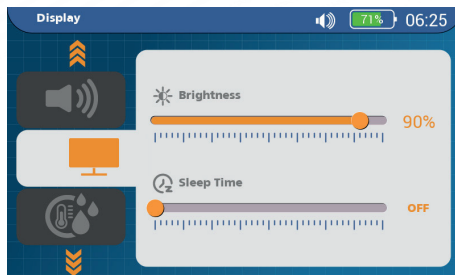

### Sleep Mode

Choose the Auto Sleep Mode for power saving

This time is changeable as 15-30-45-60-75-90-105-120 seconds and you may turn off the sleep mode completely.

## Signal filtering and temperature and moisture measurement unit

### How to connect the unit :

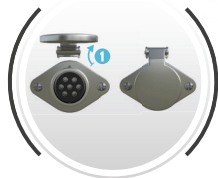

- 1 To connect the unit for measuring temperature and humidity in the place designated on the device board Lift the cover up.

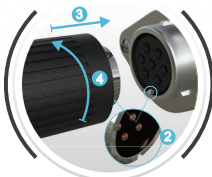

- 2 Match the notches on the jack with the plug.
- 3 Insert the plug firmly.
- 4 Twist the outer shell on the plug, counterclockwise while maintaining pressure.



- 5 Twist the outer shell clockwise to lock into position to complete the connection process securely.

For the process of unplugging the plug, follow the reversal of the previous steps.

You can see the status of the unit on the screen if it is connected or not (ready \_ offline) and you can also see the current measurements of temperature and moisture.

Press the right arrow key to enter, then press the right ◀ or left arrow ▶ to move the cursor to set the temperature unit (Fahrenheit or Celsius) according to the measurement unit used in your country, then press the Back key to save the changes.

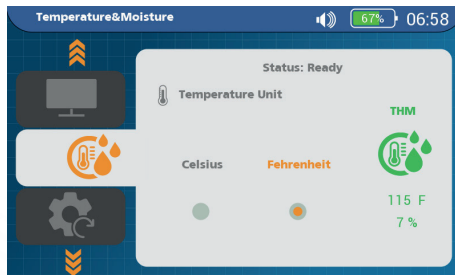



## How to use the temperature and moisture measurement unit

How to use the temperature and moisture measurement unit:

In order to use this unit, a suitable place must be found to plant it carefully by placing the distance spacers between the two probes of the unit at the two probe heads, then performing the planting process near the device and away from stones and solid objects, and it is preferable to wait for at least one minute after which the temperature and moisture level can be read.

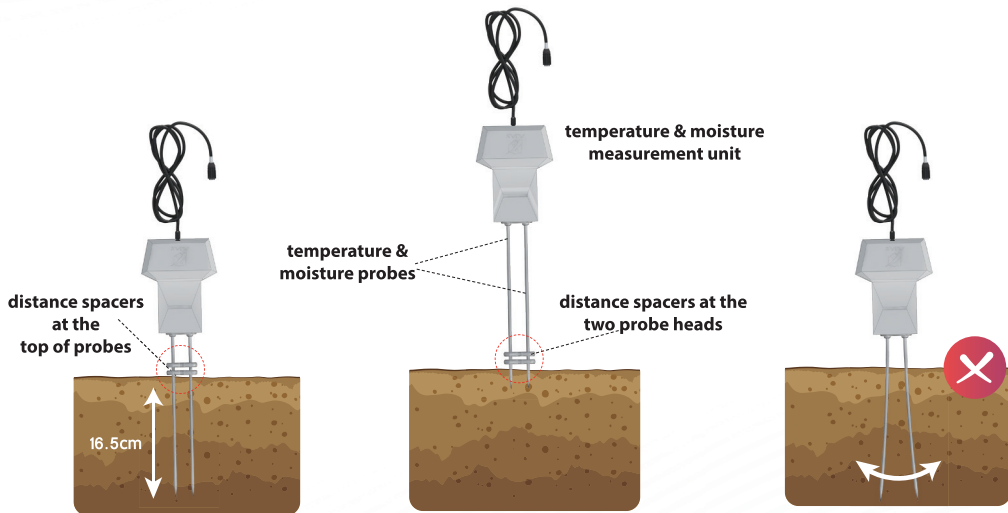

## Factory Reset

This menu shows the factory reset options



### Factory Reset:

This option resets all settings to their default values as well as clears all history from scan results on all systems.

### Memory Reset:

This option deletes all saved scans for all systems.

## About Device

Includes basic information about the device:

Software version

Device version

Screen version

Screen version details

Battery

Software release date



## General Instructions

Fully charge the device's battery before your prospecting journey to do as many scans as possible and work on the device for as long as possible  
A suitable place must be chosen to place the device away from drilling machines, then the user inserts the probes into the soil in the chosen place.

If manual scanning is chosen, then only planting two probes is sufficient for the scanning process, with the device between them

When using the rest of the systems, then we need to plant four probes so that they are distributed in the form of a square, we put the device in its center, and when the planting of the probes is finished, we extend the wires of the four rollers and connect them to the heads of the probes, using the clips designated for that, provided that the rollers remain on the bottom of the bag to remain balanced Then we connect the four short wires between the device panel and the rollers centers.

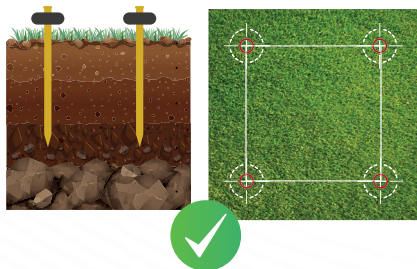
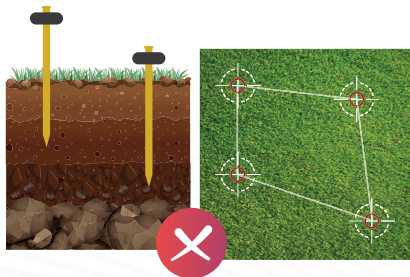

## Manual Scan

Automatic scanning performs a comprehensive scanning of the six lines (F, E, D, C, B, A) and is characterized by ease and speed. Move the cursor using the control arrows to select what is required

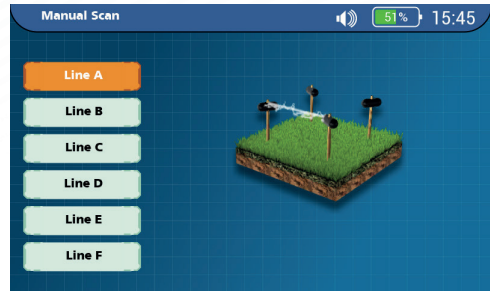

Press **OK** to start the search process and give the result in the form of a table which includes the following information:

- 1\_ Line name
- 2\_ Average
- 3\_ Type
- 4\_ Salinity
- 5\_ Depth

You can save the result through moving using the arrows and press on Save by pressing **OK** .

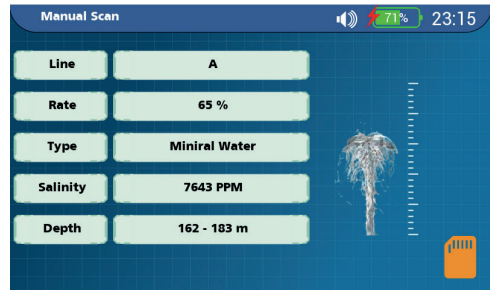

## Automatic Scan

Automatic scanning performs a comprehensive scanning of the six lines (F, E, D, C, B, A) and is characterized by ease and speed.

Move the cursor using the control arrows (◀) (▼) (▲) (▶) to select what is required.

When entering automatic scanning, the unit for measuring temperature and moisture is optional, activate or cancel (ON-OFF)

Before starting, connect the temperature and moisture unit if you want to work with it

Using the arrow keys, put the unit in the ON state. Ensure that the temperature is read and stable before starting the search. Press the right arrow key to move the pointer to "Start" and then press (OK) to start the search process.

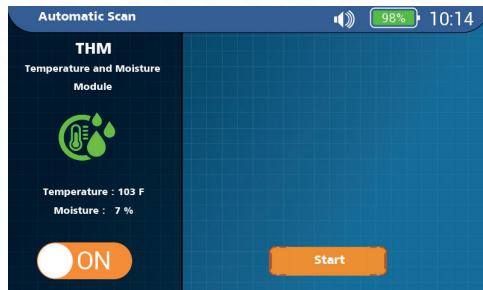



The device begins by making sure that all electrodes are connected before starting the scanning process

If one of the electrodes is unplugged, a message appears to you and the unplugged electrode is marked. The program also allows us to make sure that the electrodes are connected correctly after that, and by means of the arrow keys, we choose to re-examine.



The device begins the automatic scanning process immediately, and upon completion, the full result for all lines appears. When you press **OK** on the line itself, the specific result for the selected line appears with full details.

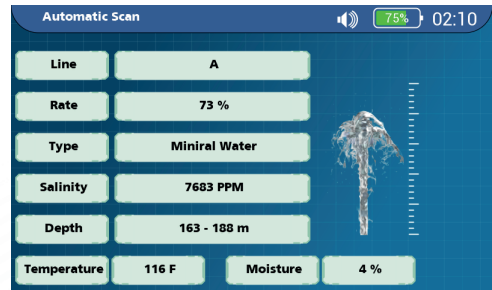
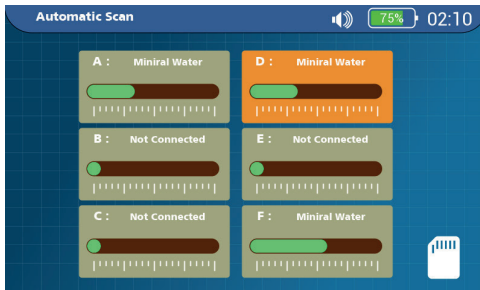



## Advanced Scan

The advanced scan performs a full scan of the six lines (A-B-C-D-E-F). This scan is intended only for experts in prospecting operations and depends on manually adjusting the surrounding parameters before starting the search process.

### Temperature and moisture Unit:

It is (optional) and it is preferable to use it to purify the signal as well and to give more accurate results for measuring the temperature and moisture of the ground's surface.

Before starting, connect the socket of the temperature and moisture unit if you want to use it with the right arrow key , put the unit in the ON state, or with the left arrow key , put the unit in the OFF state, make sure that the temperature is read and stable before starting the search process. If the unit is in the activated state, press  to move to the next setting :

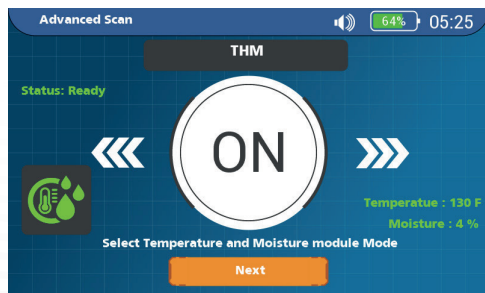

## Ground Type:

- 1 Normal
- 2 Rocky
- 3 Mixed
- 4 Clay
- 5 Sandy
- 6 Mineral

Press **OK** to move to next setting



## Target Depth:

This is to determine the required search depth. If you want to search for surface water only, deep water only, or within specific depths, you can adjust according to the following:

- 1 Depth 150 meters (feasibility ranges from 0 to 150 s)
- 2 Depth 250 meters (feasibility ranges from 150 to 250)
- 3 Depth 350 meters (feasibility ranges from 250 to 350)
- 4 Depth 550 meters (feasibility ranges from 350 to 550)
- 5 Depth 750 meters (feasibility ranges from 550 to 750 s)
- 6 Depth 1000 meters (feasibility ranges from 750 to 1000)

## Distance between probes:

The range is from 5 meters to 20 meters. Determine the planting points of the probes evenly before the planting process, so that they form the vertices of a regular square, as mentioned previously in the (General Instructions) paragraph, to ensure accuracy in the final results of the scanning process. Press OK to move to the next setting.

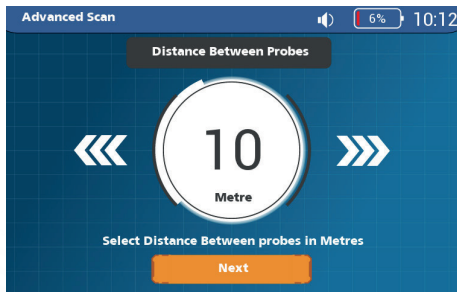
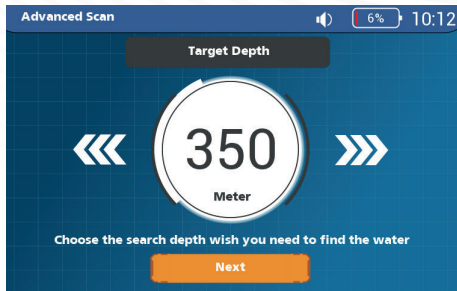

## Scan Information:

Here you can confirm all the settings that were chosen before the scanning process

Note: To modify any of the previously selected settings for the scanning process, press the back key 

Press OK to start the scanning process. The device starts by making sure that all electrodes are connected before starting the scanning process.



If one of the electrodes is not connected, a message appears, and the unconnected electrode is selected. In this case, make sure to connect the electrodes again. Then, using the arrow keys, we choose to reexamine. But if the electrodes are connected correctly:

- 1 The device begins the scanning process immediately, and upon completion, the full result of all lines appears
- 2 When you press  on the line itself, the result for the selected line appears with full details
- 3 By pressing the back key, you can return to the previous list to choose another line to show its result

## Imaging Scan

### It includes 2D and 3D scan

When entering the imaging scan, the unit for measuring temperature and moisture is optional, activate or cancel (ON-OFF)

Before starting, connect the socket of the temperature and moisture unit if you want to work with it using the arrow keys. Put the unit in the ON state. Make sure that the temperature is read and stable before starting the search.

Press the right arrow key to move the pointer to "Start", then press **OK** to start the search

The device begins by making sure that all the electrodes are connected before starting the scanning process. If one of the electrodes is not connected, a message appears to us, and the unconnected electrode is identified. The program also allows us to ensure that the electrodes are connected correctly, and then with the arrow keys we choose to re-examine,

Upon completion, a two-dimensional drawing of the scanned land appears, indicating the location of the target and the percentage of water through color

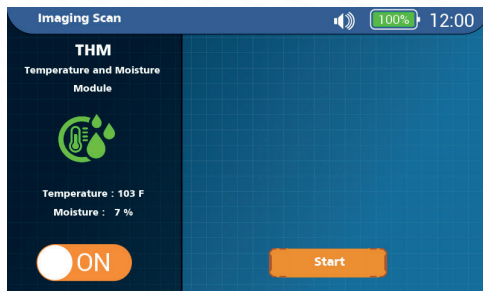



## 2D Drawing :

It is a graphic showing the location of water and the percentage of water in the ground by color.

- 1 red color and its gradations / at low or non-existent percentages.
- 2 green color and its gradations / at medium percentages
- 3 blue color and its gradations / at high percentages.

using the arrow keys select "Test Target" and then press **OK** and by using the arrow keys, you can move within the drawing and read the rate and depth of the selected point, as shown in the figure **OK** use the arrow keys and choose "3D", then press

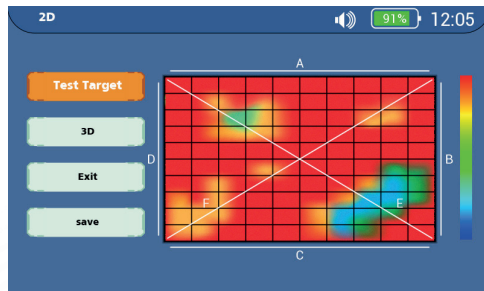
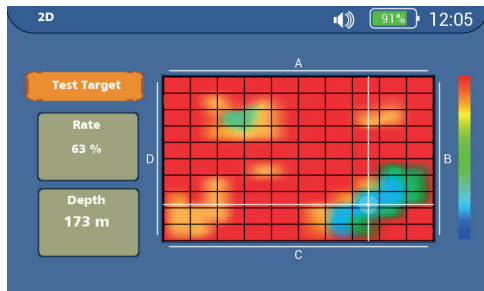

## 3D Scan :

The 3D drawing page contains the following icons:

(Rotate, Zoom, Top view, Side view, Depth Check, Reset) If the set of icons is not selected (it appears in a red frame), press the back key to select it.

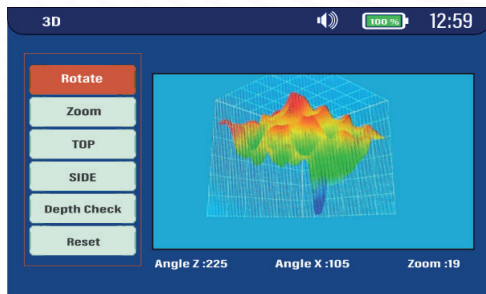

### 1 Rotate

Using the arrow keys, select Rotate and press **OK** the selection frame will change to the drawing, and then with the arrows **◀** **▼** **▲** **▶** you can move the drawing in all directions, and you can see the actual angle through the axes (X, Z)

When the modification is completed, press **OK** for accurate drawing with Colors

Press the back key **↩** to return to the group of icons

## 2 Zoom

Using the arrow keys choose Zoom in and press 

Use the  to zoom in on the graphic

Use the  to zoom out

Use the   to rotate the z-angle

When the modification is finished, press 

for an accurate drawing with colors

Press the back key  to return to the group of icons

## 3 Top View

Using the arrow keys, choose Projection Top and press 

to draw accurately with the colors directly

## 4 Side View

Use the left and right arrow keys  , then choose a side view and press .

The 3D drawing appears from the left or right side

Press the back key  to return to the set of icons

## 5 Depth Check

Using the arrow keys choose Check Depth and press 

Using the up and down arrow keys   , you can move the middle grid as an indicator of the depth at which this grid stands, specifying the distance in metres

Press the back key  to return to the group of icons

## 6 Reset

Using the arrow keys choose Reset and press 

to have the program reset all angles and zoom to default

## How to save scans

After completing the scanning process, you can save the result by moving with the arrow keys (◀▶▲▼) and pressing the Save icon with the (OK) key

A list of previously saved scans appears

Move with the arrow keys (▲▼) to choose the desired save location, press (OK)

A keyboard appears for you to choose the name of the desired file, while the default name for it is the date and time the scan was performed

To delete a character, you must use the return key (↵)

Using the arrow keys and then using

the (OK) key, enter the desired name

When you finish setting the file name, press ENTER and then the (OK) key

### Note:



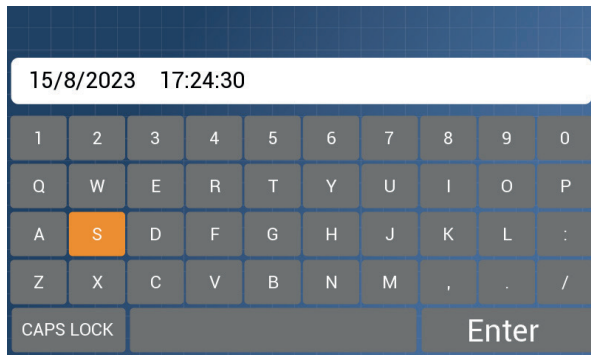

The file name must be in English



This page shows previously saved scans and search results so that the user can review these results.

It contains 4 pages for storing scan types, each type separately.

- 1 Manual scan
- 2 Auto scan
- 3 Advanced scan
- 4 Imaging scan

Press the arrow keys   and choose the desired scan, then press the  key  
Using the arrow keys   you can select the file to display.

## Battery and Charger

When the battery is low, less than 30% ,The battery icon will appear on the screen in a large size in the middle of the screen in orange (29%), and when it is less than 20% , it will appear in red (19%).

If it continues to drop to 0% (0%), the device will release an alarm and then automatically shut down.

When the battery is completely empty, it is preferable not to turn on the device immediately after connecting the charger. Leave the battery on for a few minutes after connecting the charger before turning on the device. The device can be used while charging, but this will increase the time to fully charge the battery.

### Battery charging tips and precautions:

Use the charger and cable supplied by Ajax (PD Type C), see the picture at the bottom right of the page

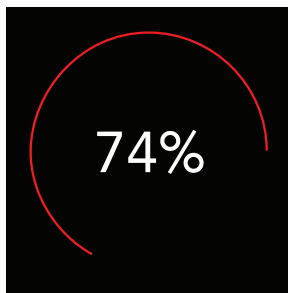

When using an unsupported charger (that does not support the PD feature), the device will not charge and an icon will appear indicating this. See the image at the bottom of the page on the left

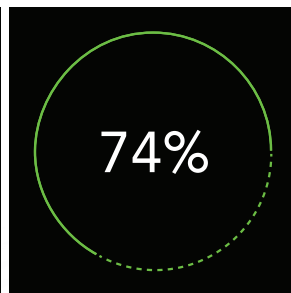

unsupported charger



supported charger  
(PD Type C)

For better performance and to increase battery life, it is preferable to charge the device when the battery percentage is less than 20%  , and not to use the device while charging, leaving it to reach a full charge  , and not to charge the battery intermittently.

To save energy, unplug the charger from the electrical socket when charging is finished .

### Operating environment precautions:

Do not store the device in an extremely hot or cold area

Do not leave the device exposed to sunlight for long periods of time, especially if the cover of the device is open

Do not leave the device in places exposed to extreme heat, such as inside a car in the summer





## WEEE (Waste electrical and electronic equipment) statement

To protect the global environment and as an environmentalist

AJAX must remind you that

Under the European Union ("EU") Directive on Waste Electrical and Electronic Equipment,

**Directive 96/2002/EC, which takes effect on**

**August 2005 ,13, products of»electrical and electronic equipment» cannot be discarded as municipal waste anymore, and manufacturers of covered electronic equipment will be obligated to take back such product at the end of their useful life. AJAX will comply with the product take back requirements at the end of life of AJAX branded products that are sold into the EU. You can return these products to local collection points.**



## WEEE (Waste electrical and electronic equipment) statement

### European union:



Batteries, battery packs, and accumulators should not be disposed of as unsorted household waste. Please use the public collection system to return, recycle, or treat them in compliance with the local regulations.

### Taiwan: 廢電池請回收



For better environmental protection, waste batteries should be collected separately for recycling or special disposal.

### California, USA:

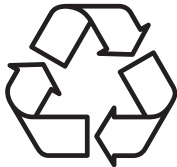

The button cell and Li-ion battery may contain perchlorate material and requires special handling when recycled or disposed of in California.

For further information please visit:

<http://www.dtsc.ca.gov/hazardouswaste/perchlorate/>

## Contact information

📍 1201 N.W. Briarcliff Parkway, 2nd Floor,  
Kansas City, Missouri, 64116 USA

☎ +1 816 298 0485

☎ +1 816 399 3744

✉ [info@ajaxdetector.com](mailto:info@ajaxdetector.com)

🌐 [www.ajaxdetector.com](http://www.ajaxdetector.com)

## Environmental Policy

The product has been designed to enable proper reuse of parts and recycling and should not be thrown away at its end of life.

Users should contact the local authorized point of collection for recycling and disposing of their end-of-life products.

## Visit the AJAX website

and locate a nearby distributor for further recycling information.

Users may also reach us at [info@ajaxdetector.com](mailto:info@ajaxdetector.com) for information regarding proper Disposal, Take-back Recycling, and Disassembly of AJAX products.





**AJAX**  
DETECTION TECHNOLOGY

